

# INSTALLATION INSTRUCTIONS

## 20FT Large Portable Light Box

### Attention:

Please switch the LED panels progressively after assembly, this helps avoid an overload of electrical currents. If all the lights are switched at once, then potential damage to the LED panel.

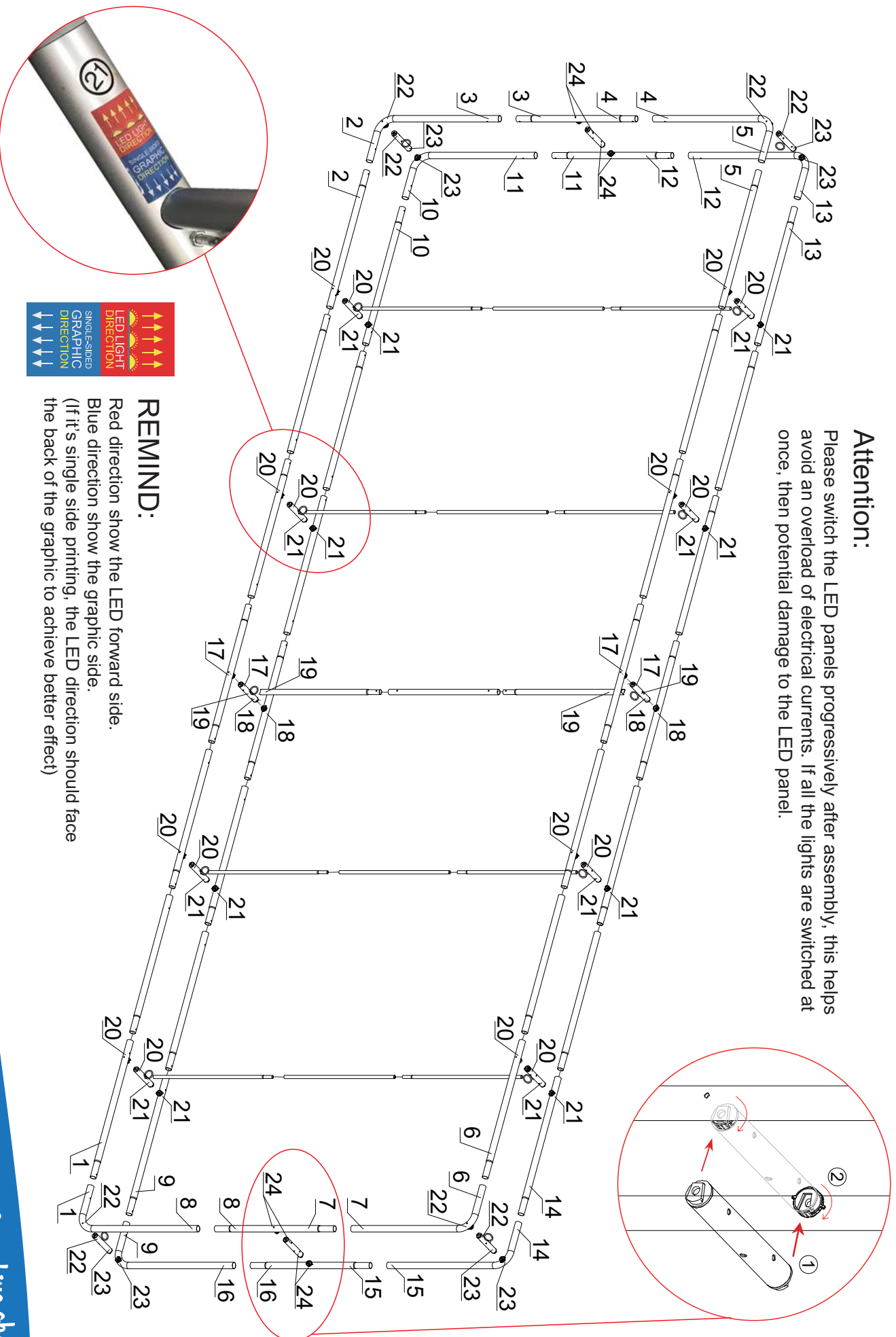

### REMIND:

Red direction show the LED forward side.  
 Blue direction show the graphic side.  
 (If it's single side printing, the LED direction should face the back of the graphic to achieve better effect)

# INSTALLATION INSTRUCTIONS

## 20FT Large Portable Light Box

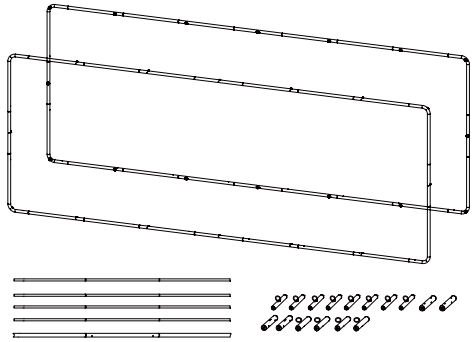

1

Put both horizontal tube connect with same label in to a frame, as the picture shown, and prepared the middle tube



2

Go four horizontal corners firstly with the middle connector.

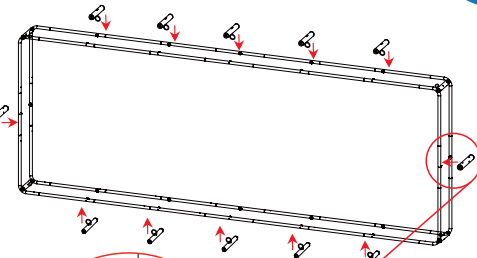

3

Install the rest horizontal connectors

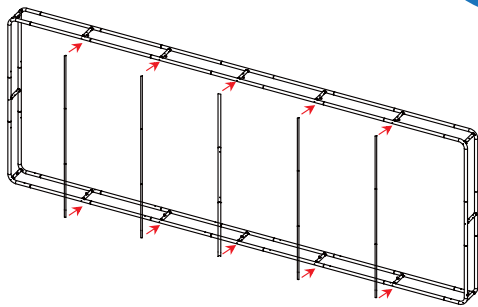

4

Install the middle tube to finish the frame

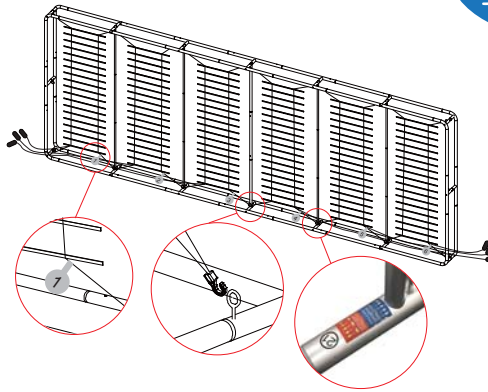

5

Hang the LED light into the frame sequentially, beware the direction of the LED panel

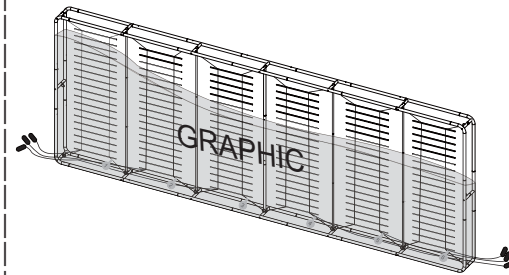

6

Set up graphic to the frame. ( Light power line should be out from holes in graphic; If it's single side printing, the LED direction should face the back of the graphic to achieve better effect)

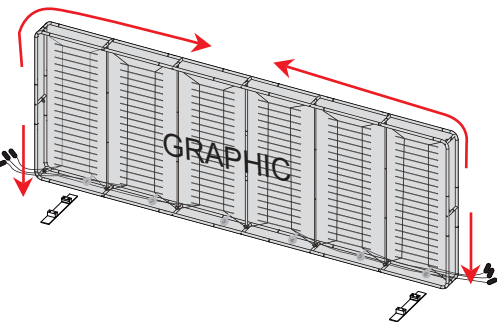

7

Zip the zipper. Fix the whole frame into the base and lock the slider with allen key

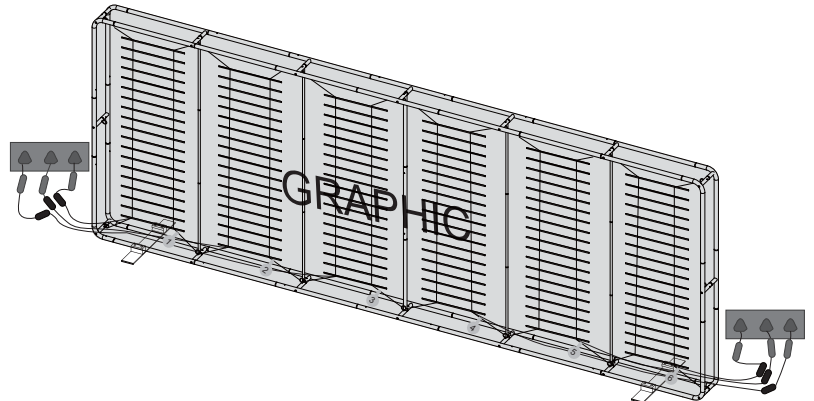

8

Connect the power to finish.